

Top

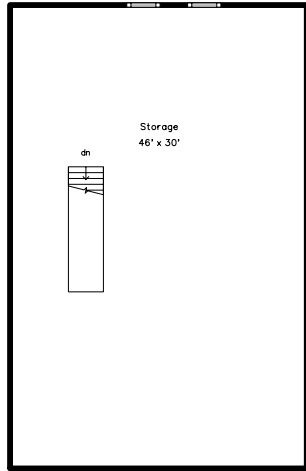

Upper

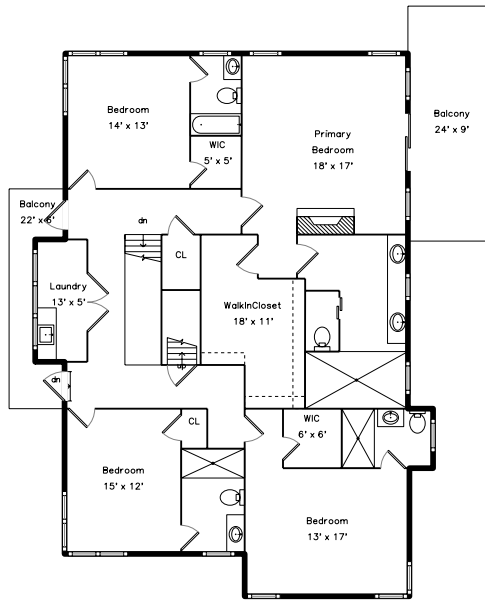

Lower

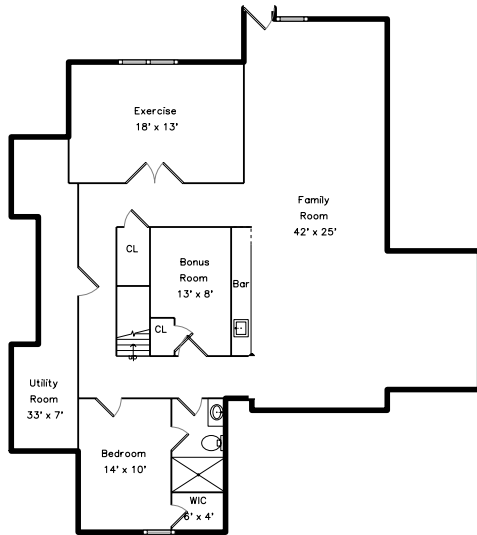

Main

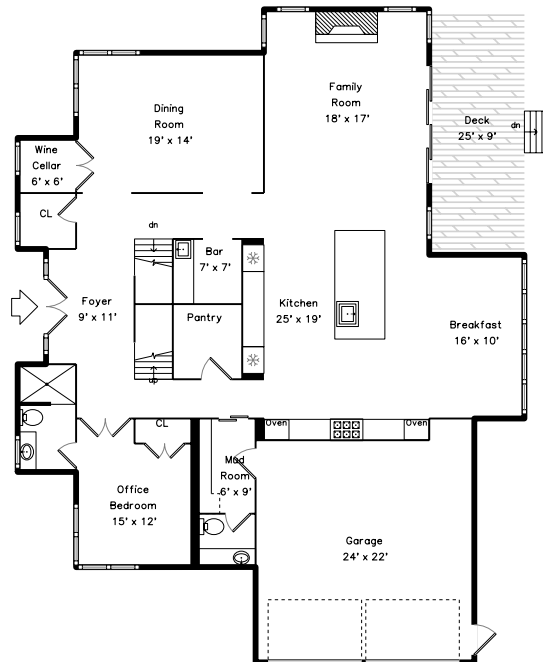

7 Jane Road
Newton, MA 02459

PicturePlan by  vis-home

Measurements may not be 100% accurate.
Floor plans are provided for convenience only.
Room sizes are not used to calculate area.

Top

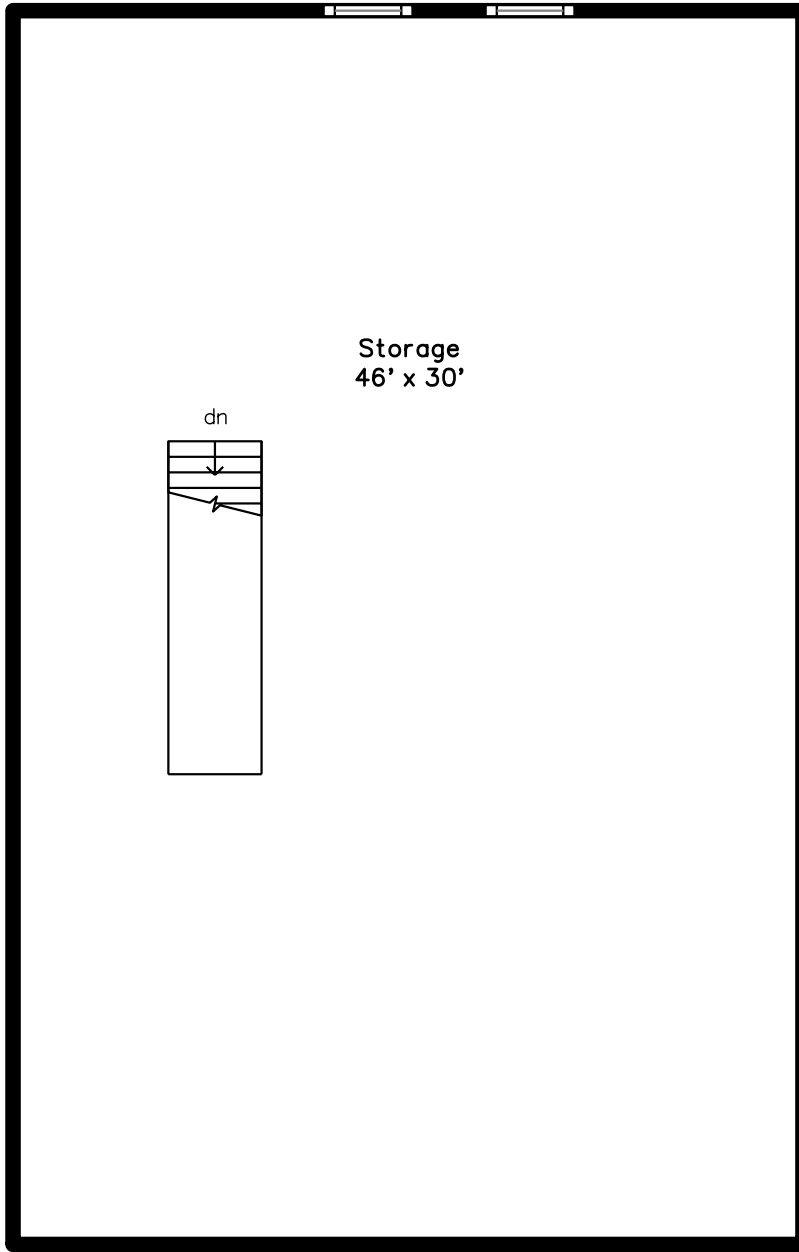

Storage
46' x 30'

dn

Upper

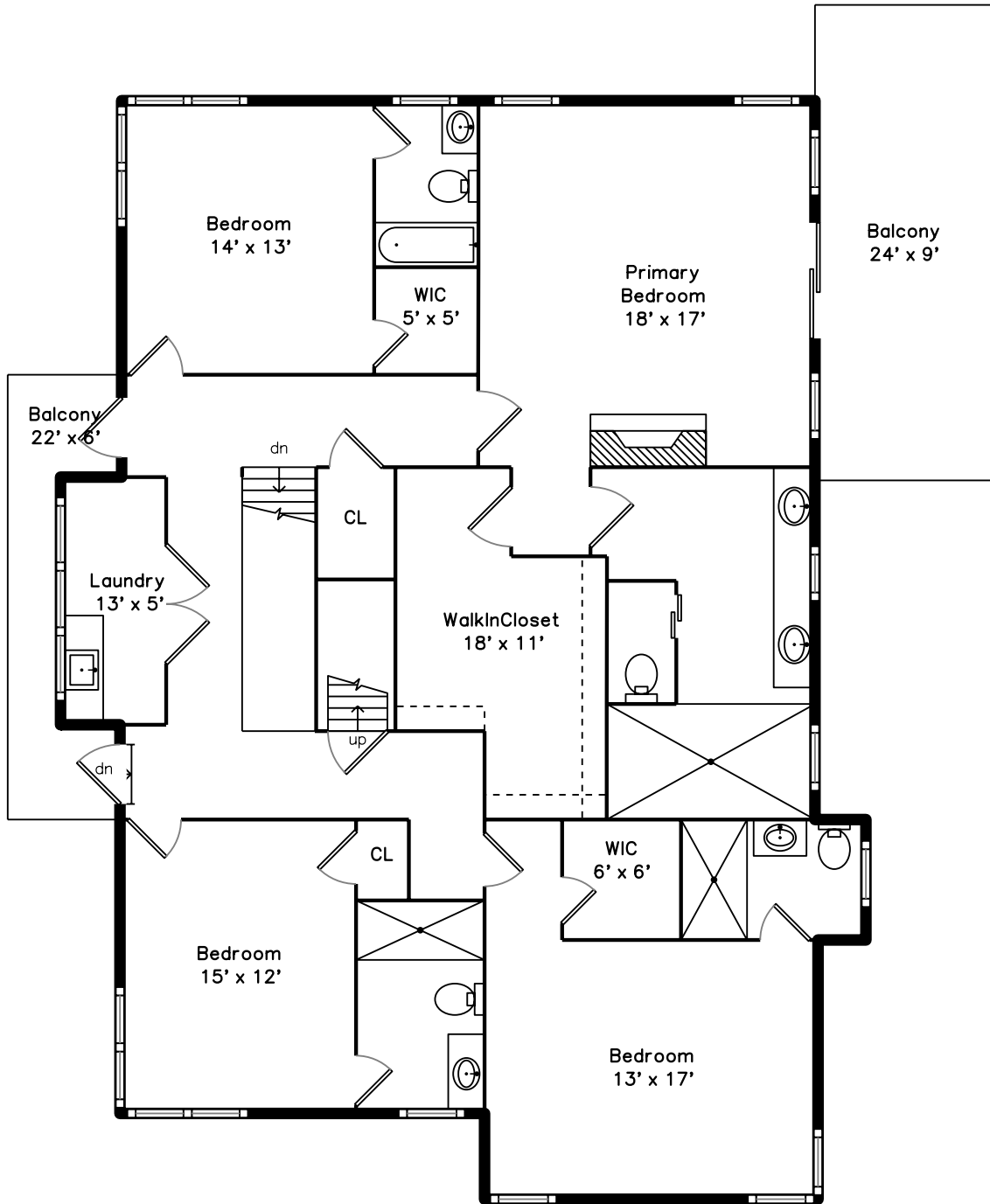

Main

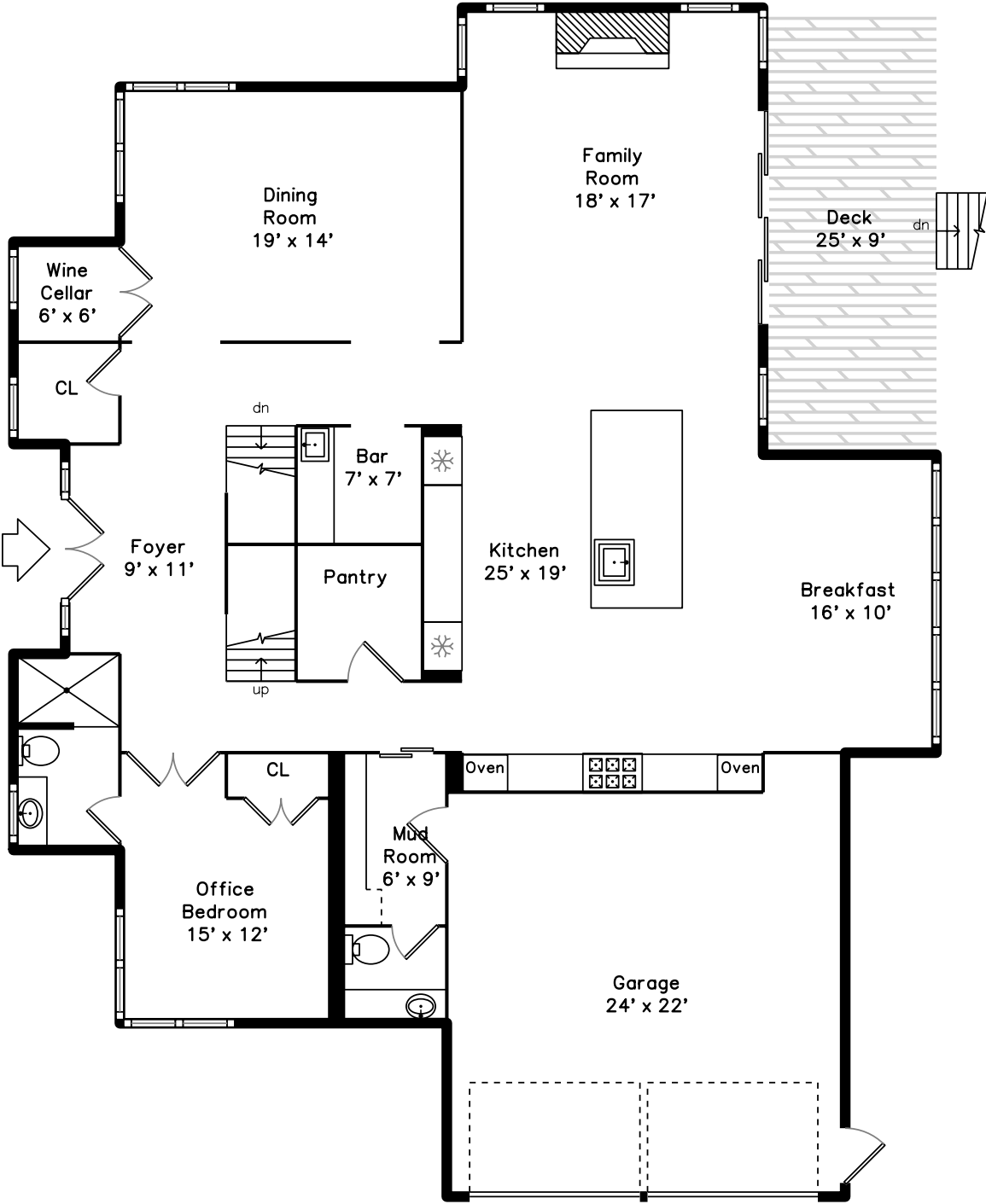

Lower

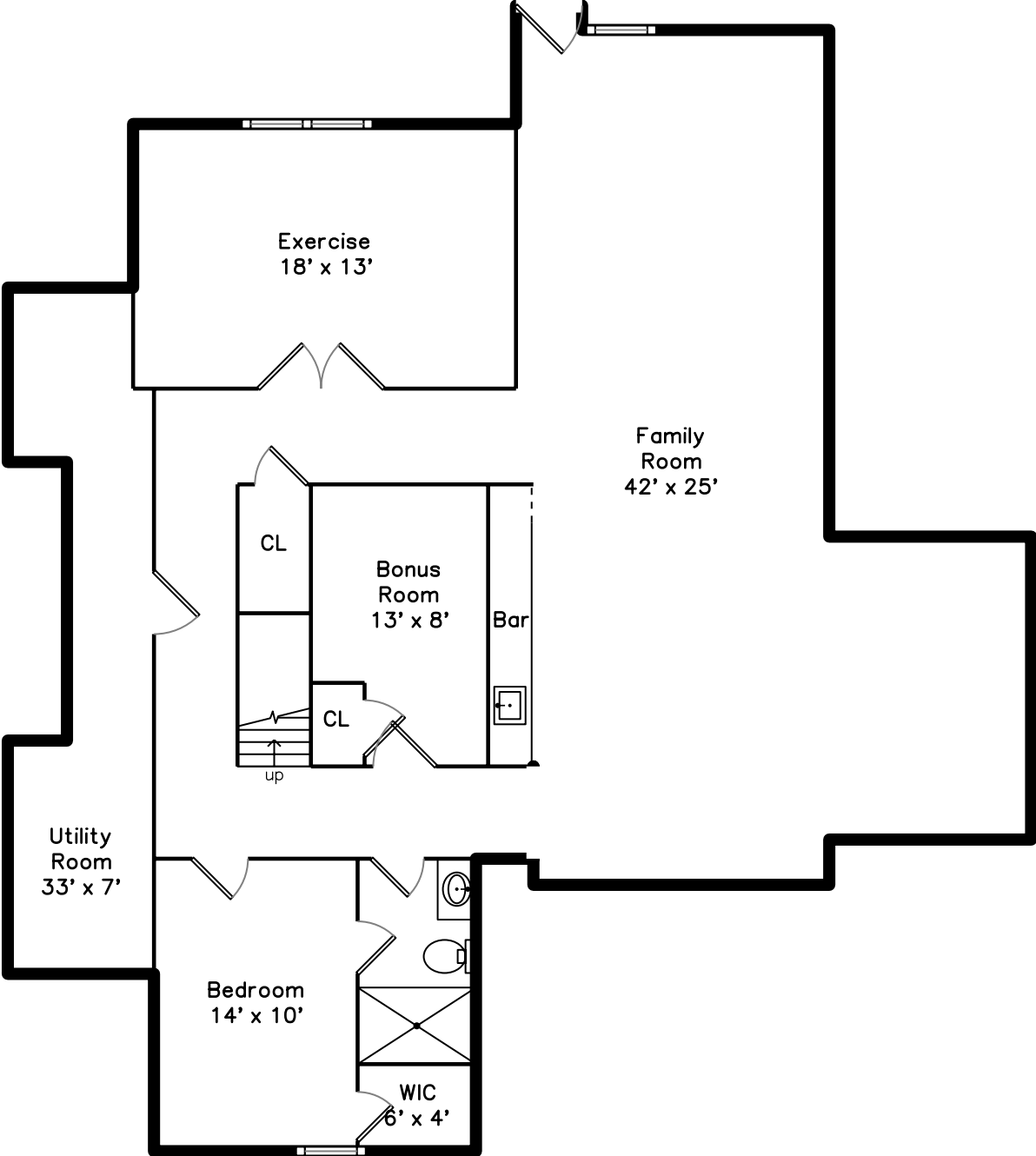



Outside



Outside



Outside



Outside



Outside



Outside



Outside



Foyer



Foyer



Family Room



Family Room



Dining Room



Dining Room



Kitchen



Kitchen



Breakfast



Breakfast



Bar



Pantry

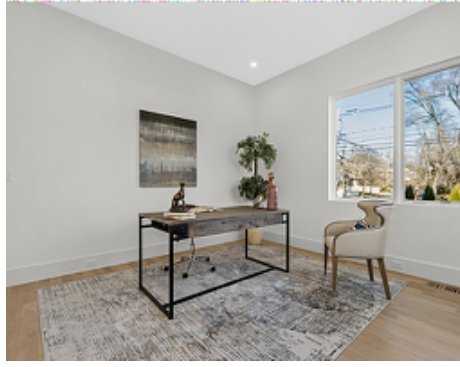

Office Bedroom



Office Bedroom



Powder Room



Wine Cellar



Mud Room



Hall



Primary Bedroom



Primary Bedroom



Primary Bedroom



Primary Bedroom



Bedroom



Bedroom



Bedroom

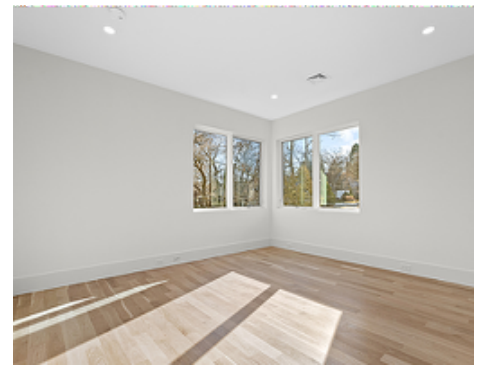

Bedroom



Primary Bathroom



Primary Bathroom



Primary Bathroom

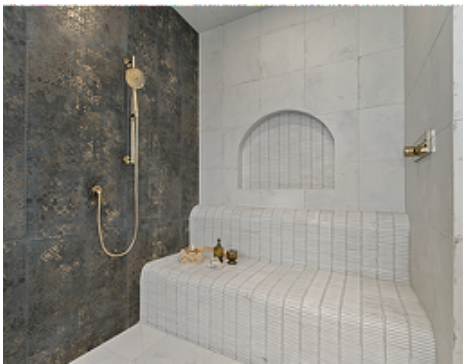

Primary Bathroom



Bathroom



Bathroom



Laundry



Balcony



WalkInCloset



Family Room



Family Room



Family Room



Exercise



Bedroom



Bathroom